



KAWASAKI ZX-6R (2009)

RACING & EVOLUTION EXHAUST SYSTEM

Akrapovic Racing and Evolution systems are designed for racing-oriented riders who demand maximum performance. Both systems feature exceptional production quality, hi-tech materials and of course increased engine performance. Their quality and reputation are further augmented by the use of the high-tech HYDRO-FORMING production process to form the header tubes. Beside performance you will also benefit from great weight savings, up to 7.51 kg if compared to stock system. The change will be also visual as our HEXAGONAL muffler perfectly fit the exterior line of the Ninja and add a clean racing image. We offer titanium or carbon fiber mufflers. Evolution system is made entirely of our exclusive high grade titanium while Racing system uses stainless steel header tubes and link pipe. Systems are not homologated and are developed only for race track use.

PERFORMANCE

Measurements of the Akrapovic EVOLUTION system on the KAWASAKI ZX-10R (without muffler insert):

Power & Torque: the exhaust system modification with the EVOLUTION system results in a major boost in performance, delivering a massive 122.1 HP at 14220 rpm on back wheel. But the increased power isn't available just at the top of the range; the system shows its quality already from 5500 rpm up through entire rpm range. Max. increased power between the Akrapovic and the stock system is 7.8 HP at 14500 rpm. Besides this, the torque is substantially higher in a lower rpm area at 5000 rpm and from middle to high rpm area.



PERFORMANCE			
	stock	AKRAPOVIC	max. increased power
max. rear wheel power HP / rpm (measured on Dynojet ATV)	113,9 / 13880	122,1 / 14220	7,8 / 14500

ADDITIONAL DATA					
weight comparison (kg)	stock	AKRAPOVIC		difference	
	11,22	RACING	EVOLUTION	stock - RACING	stock - EVOLUTION
		4,94	3,71	6,28	7,51

weight comparison (kg)	stock	AKRAPOVIC
		95 / 7000
legal for street use	NO	

Technical specifications of Akrapovic exhaust systems and related products subject to change without notice.

Product code: (110254) S-K6R6-ZC, (110253) S-K6R6-ZT racing
 (110256) S-K6RFT6T-ZC, (110255) S-K6RFT6T-ZT evolution
 S-K6RFT6T-ZC/3 S-K6RFT6T-ZT/3 evolution kit

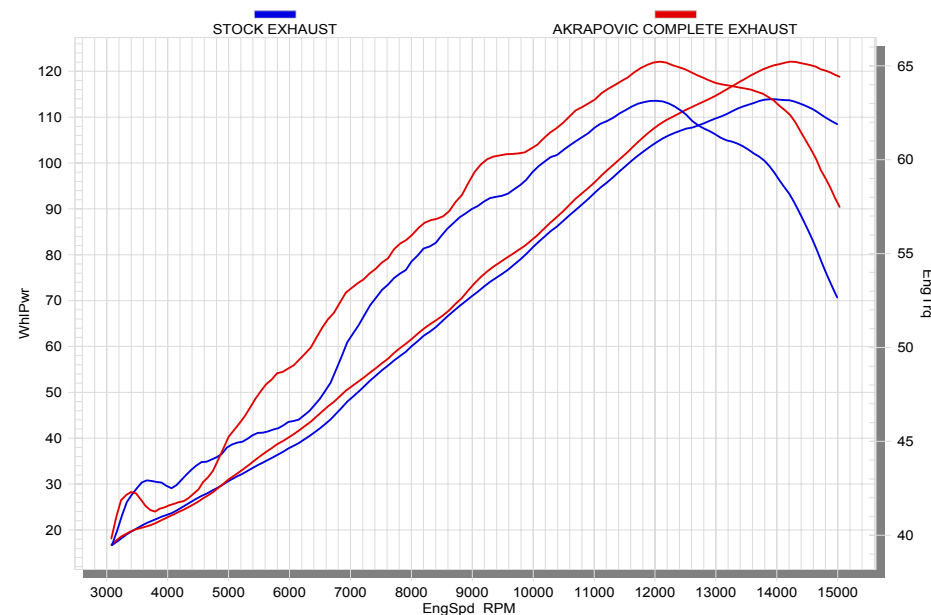

KAWASAKI 636 NINJA ZX-6R

STOCK

COMPLETE

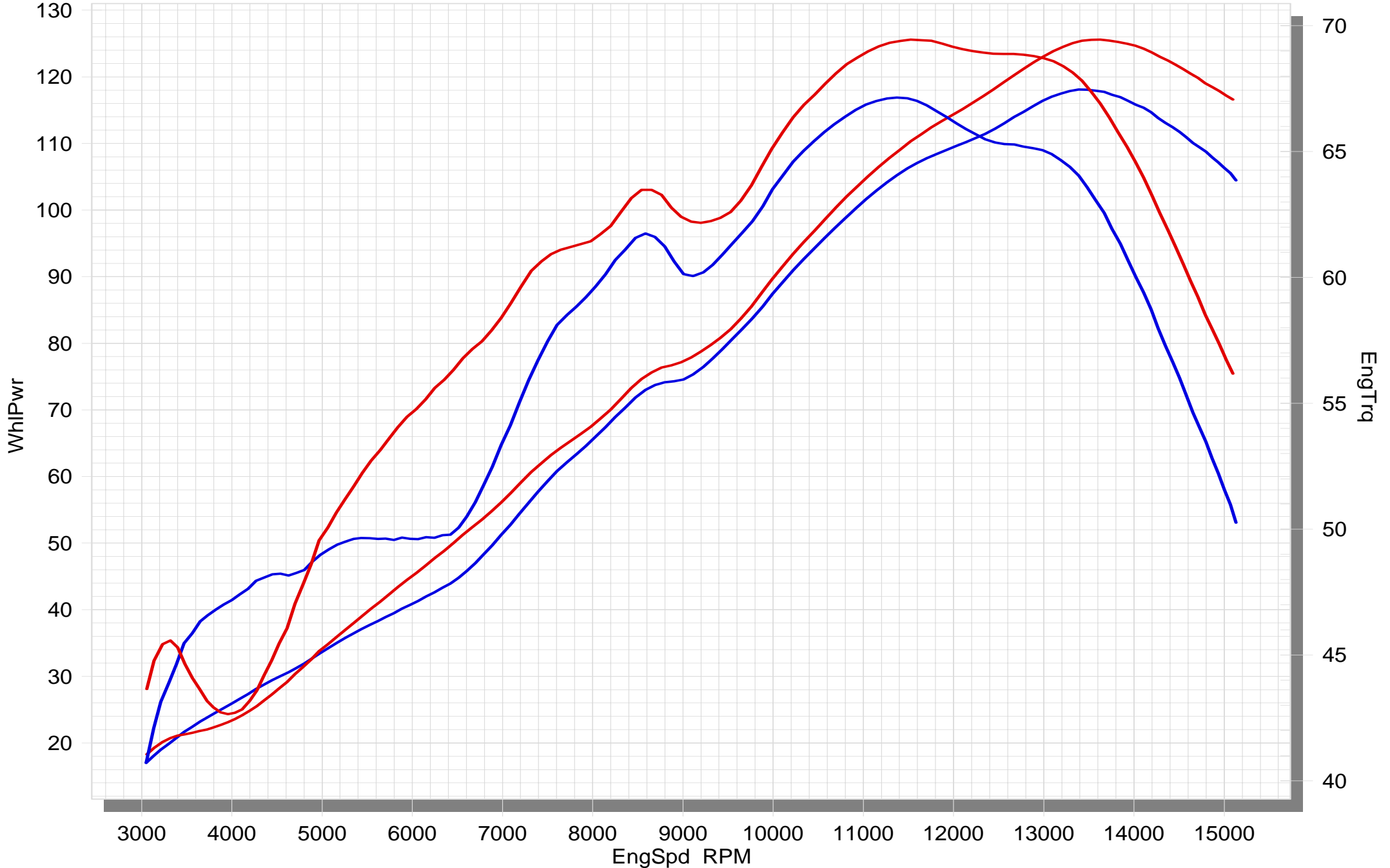

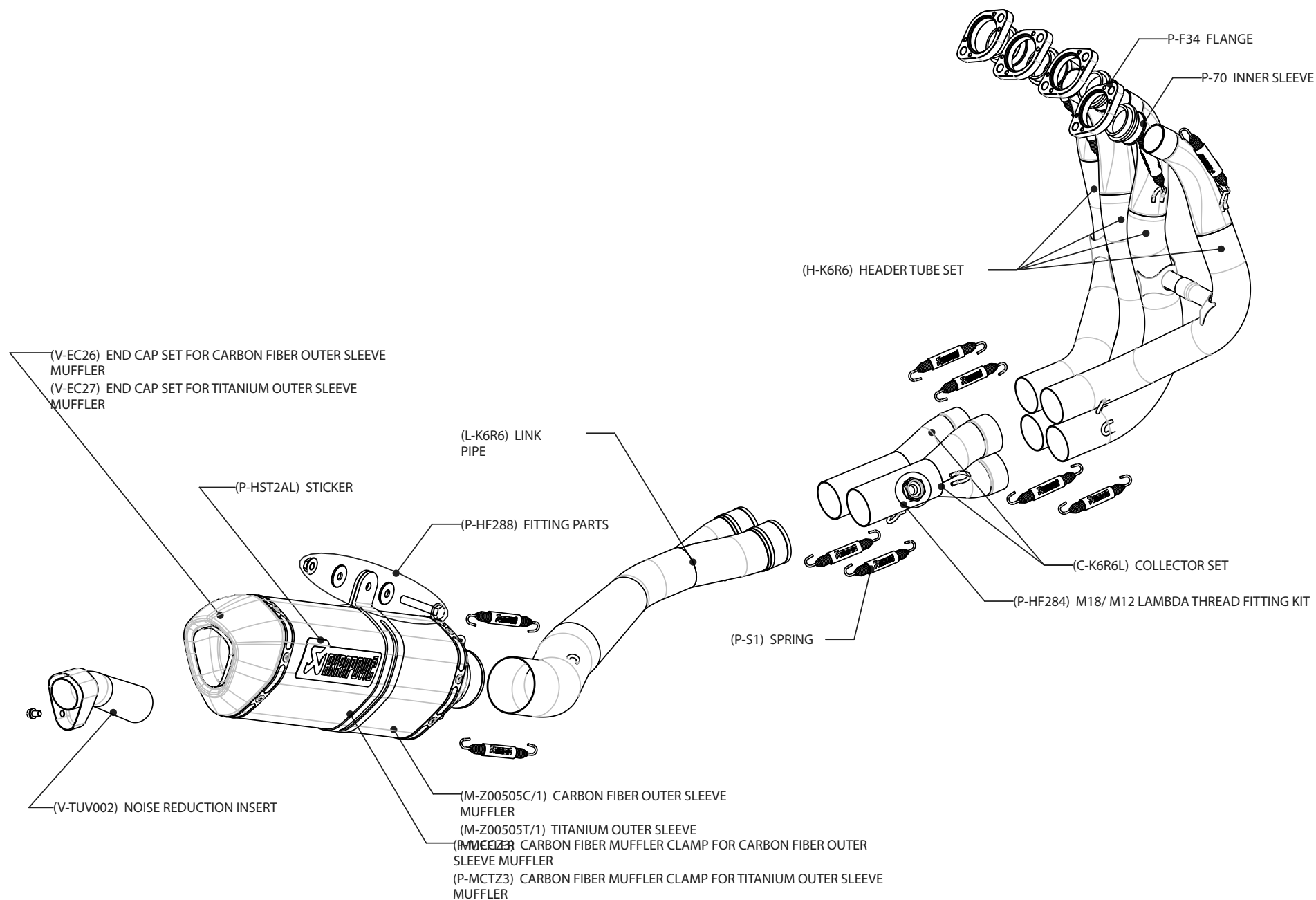

Product code: (110254) S-K6R6-ZC, (110253) S-K6R6-ZT racing

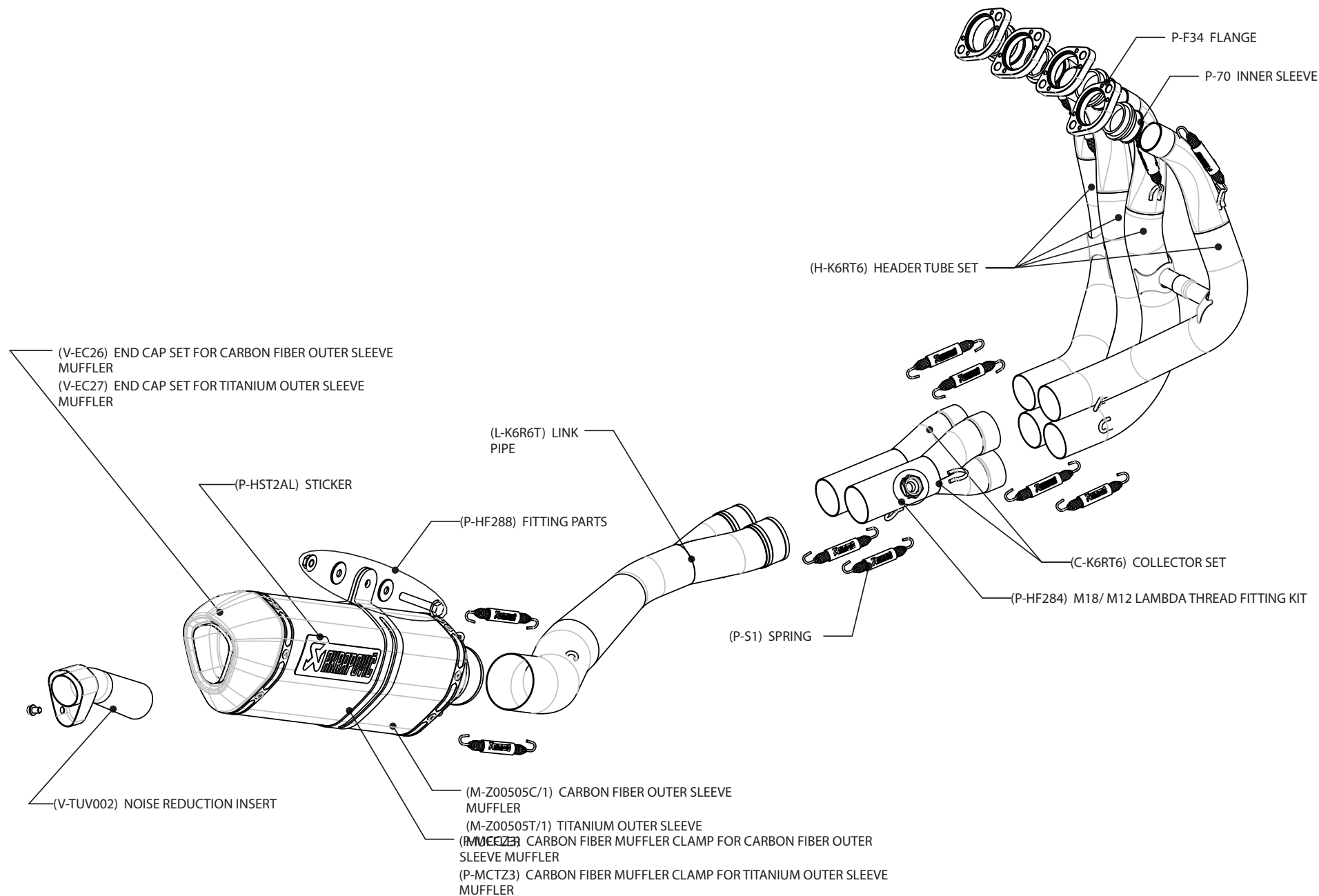

Product code: (110256) S-K6RFT6T-ZC, (110255) S-K6RFT6T-ZT evolution

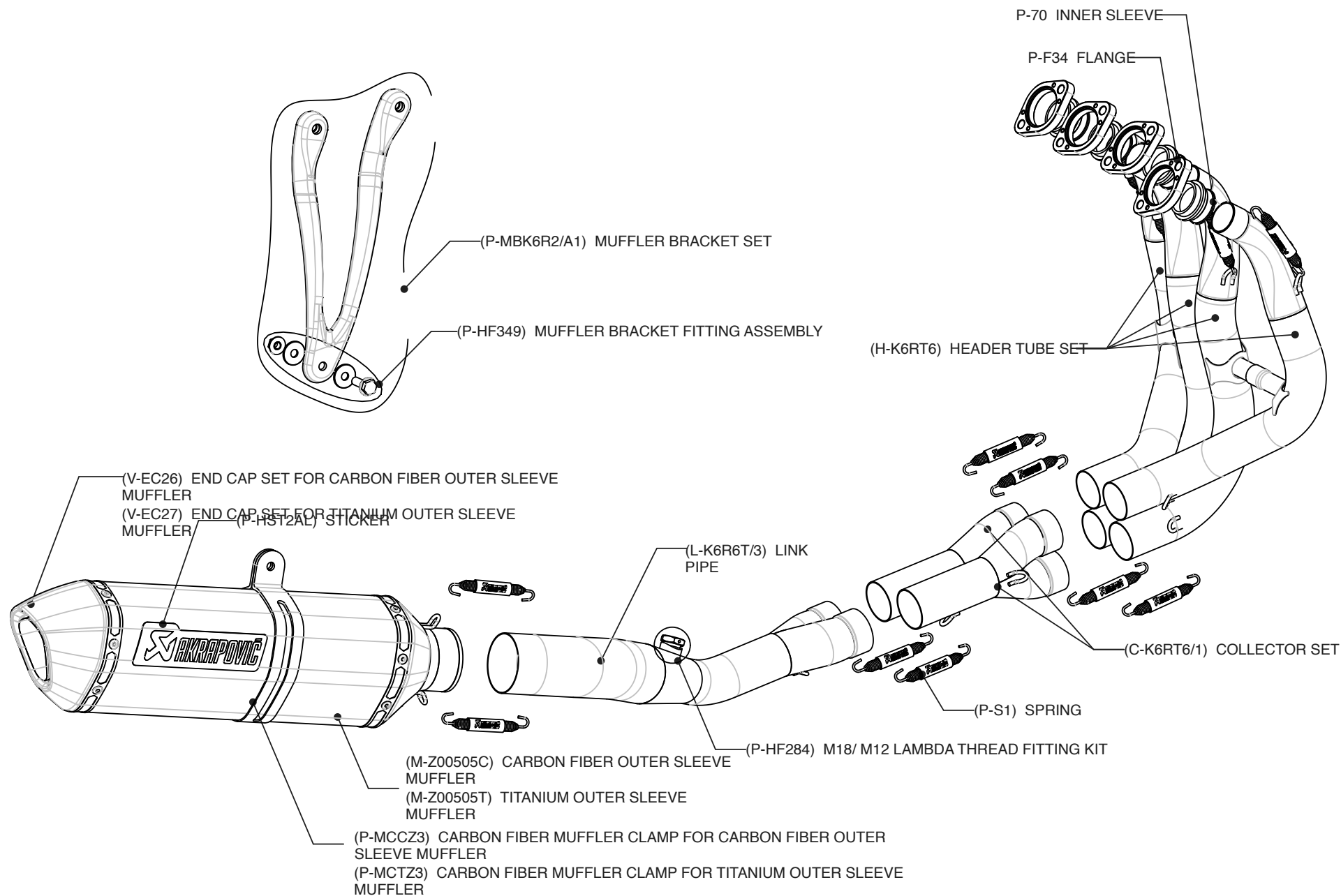

RACING LINE tube set and a street legal SLIP-ON muffler.

Warning! In case of a combination with the RACING tube set, the SLIP-ON homologation is not valid!

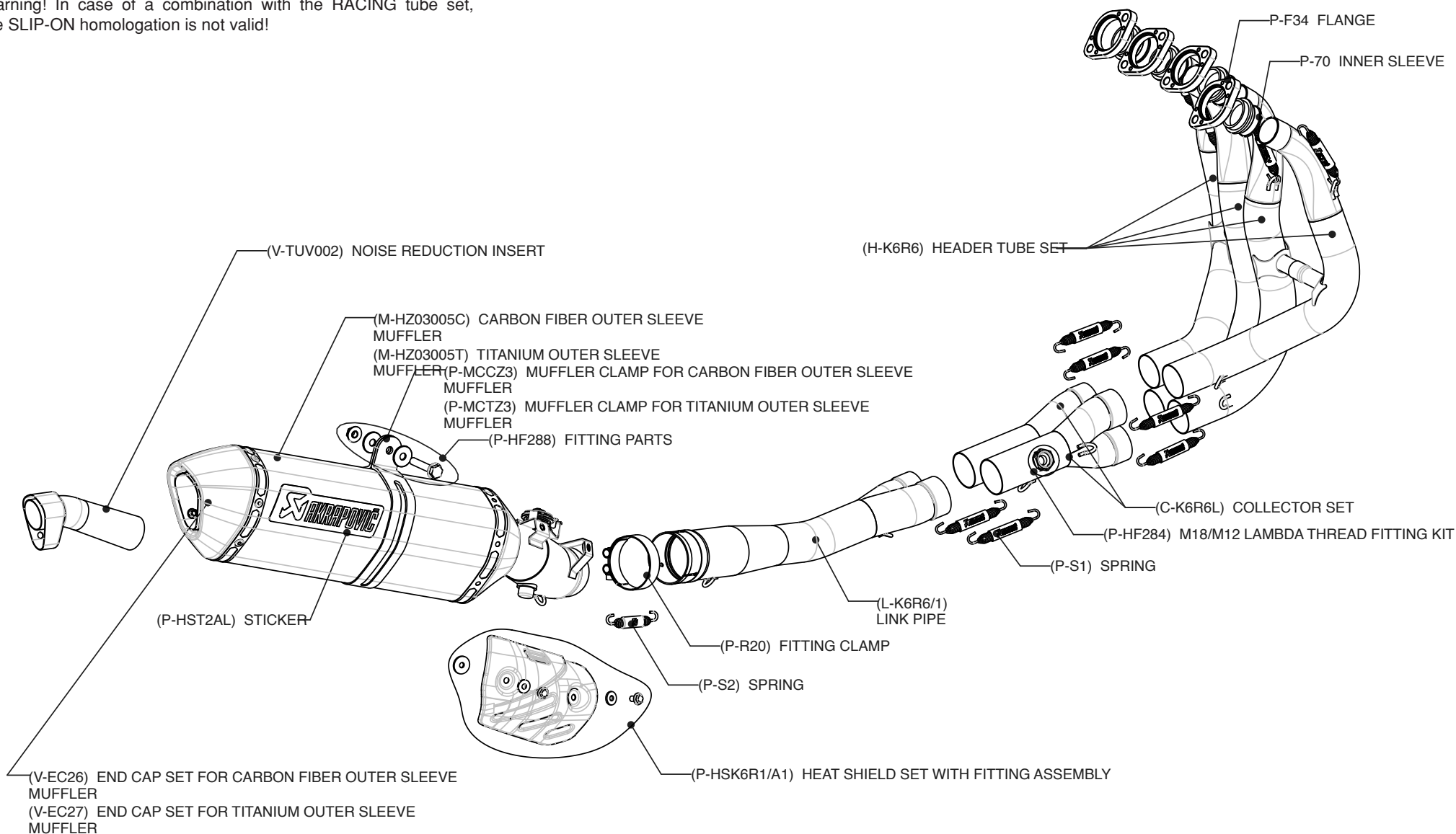

EVOLUTION LINE tube set and a street legal SLIP-ON muffler.

Warning! In case of a combination with the EVOLUTION tube set, the SLIP-ON homologation is not valid!

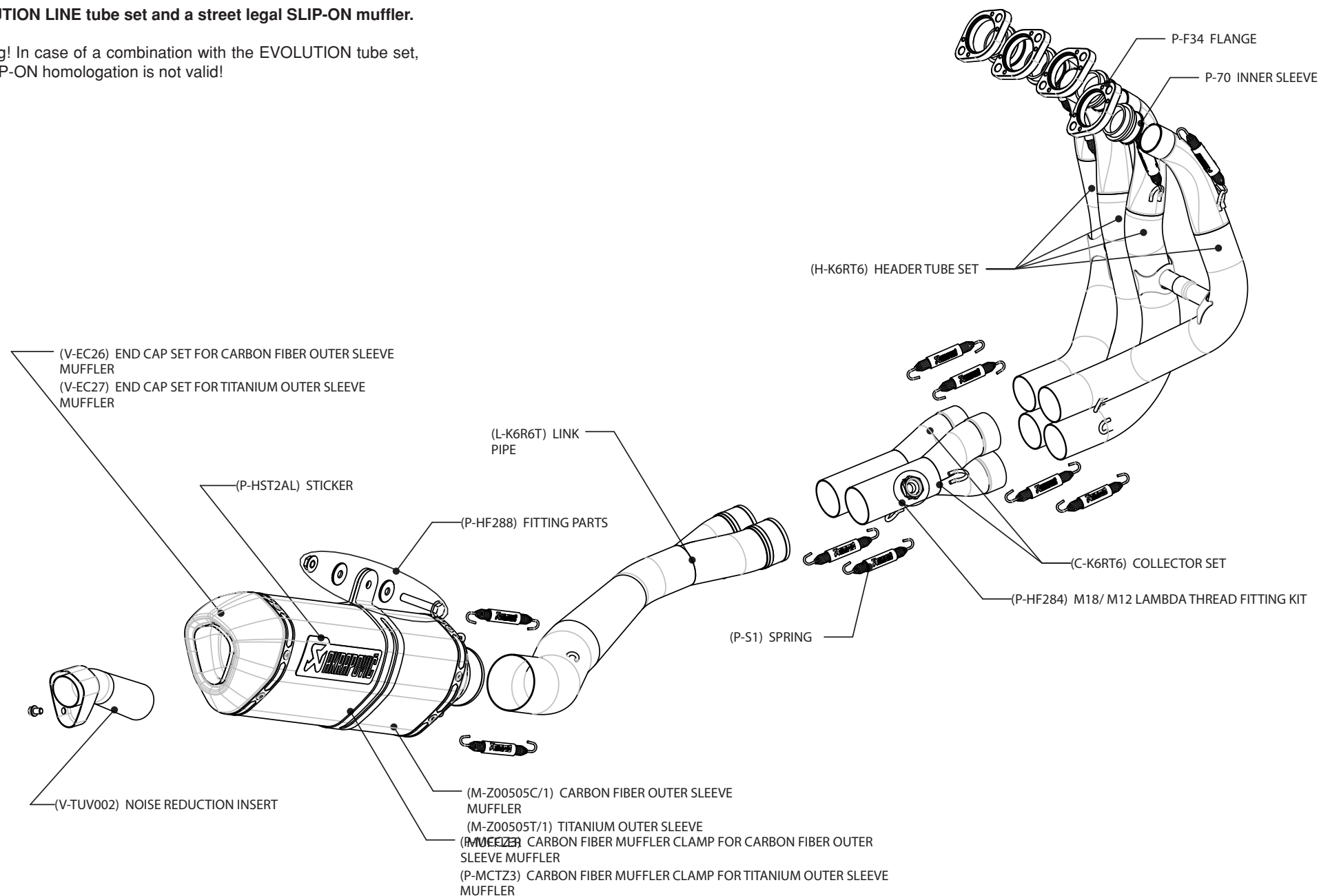

Product code: (110252) S-K6RFT6T-ZC/1, (110251) S-K6RFT6T-ZT/1 evolution headers with slip-on street legal muffler

